

DESCRIPTION:

The F3A denotes a range of SENIS Magnetic Field-to-Voltage Transducers with fully integrated 3-axis Hall Probe.

The Hall Probe contains a CMOS integrated circuit, which incorporates three groups of mutually orthogonal Hall elements, biasing circuits, amplifiers, and a temperature sensor. The integrated Hall elements occupy very small area (150 μm x 150 μm), which provides very high spatial resolution of the probe. The CMOS IC technology enables very high precision in the fabrication of the vertical and horizontal Hall elements, which gives high angular accuracy of the three measurement axes of the probe (orthogonality error < 1°, determined with an accuracy of better than 0.1°).

The application of the spinning-current technique in the biasing of the Hall elements suppresses the planar Hall effect. The on-chip signal pre-processing enables a very high frequency bandwidth (DC to 25 kHz) of the probe, and on-chip signal amplification provides high output signals of the Hall probe, which makes the transducer immune to electromagnetic disturbances.

The Hall probe is connected with an electronic box (Module E in Fig. 1). The Module E provides biasing for the Hall probe and additional conditioning of the Hall probe output signals: amplification, linearization, cancellation of the offsets, compensation of the temperature variations, and limitation of the frequency bandwidth.

The outputs of the F3A Magnetic Transducers are available at the connector CoS of the Module E: the three high-level differential voltages (V_x , V_y and V_z) proportional with each of the three measured components (B_x , B_y and B_z , respectively) of a magnetic flux density, and a ground-referred voltage (V_{pt}) proportional to the actual temperature of the Hall sensor.

KEY FEATURES:

- **Fully integrated CMOS 3-axis (B_x , B_y , B_z) Hall Probe, of which one, two, or three channels are used**
- **Very high spatial resolution (B_y : 0.03 x 0.005 x 0.03mm³; B_x and B_z : 0.15 x 0.01 x 0.15 mm³)**
- **High angular accuracy of the three measurement axes (orthogonality error < 1°, determined with an accuracy of better than 0.1°)**
- **Virtually no planar Hall effect**
- **High frequency bandwidth (DC to 25 kHz)**
- **High disturbance immunity**
- **Negligible inductive loops on the Probe**
- **Integrated temperature sensor on the probe for temperature compensation**

TYPICAL APPLICATIONS:

- Characterization and quality control of permanent magnets
- Development of magnet systems
- Mapping magnetic field
- Quality control and monitoring of magnet systems (generators, motors, etc.)
- Application in laboratories and in production lines

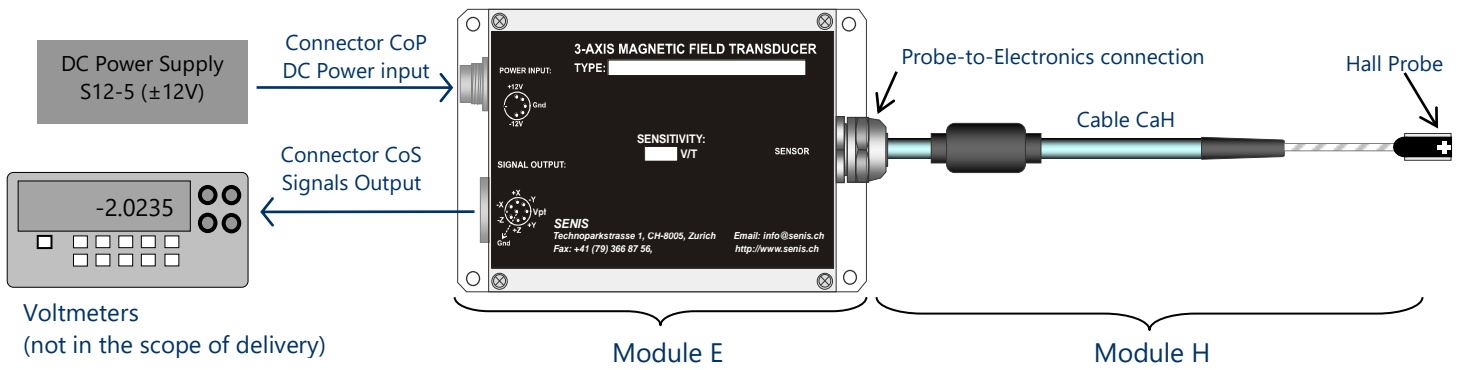

Figure 1. Typical measurement setup with a SENIS magnetic-field-to-voltage transducer with fully integrated Hall Probe (Module H) and Electronic (Module E)

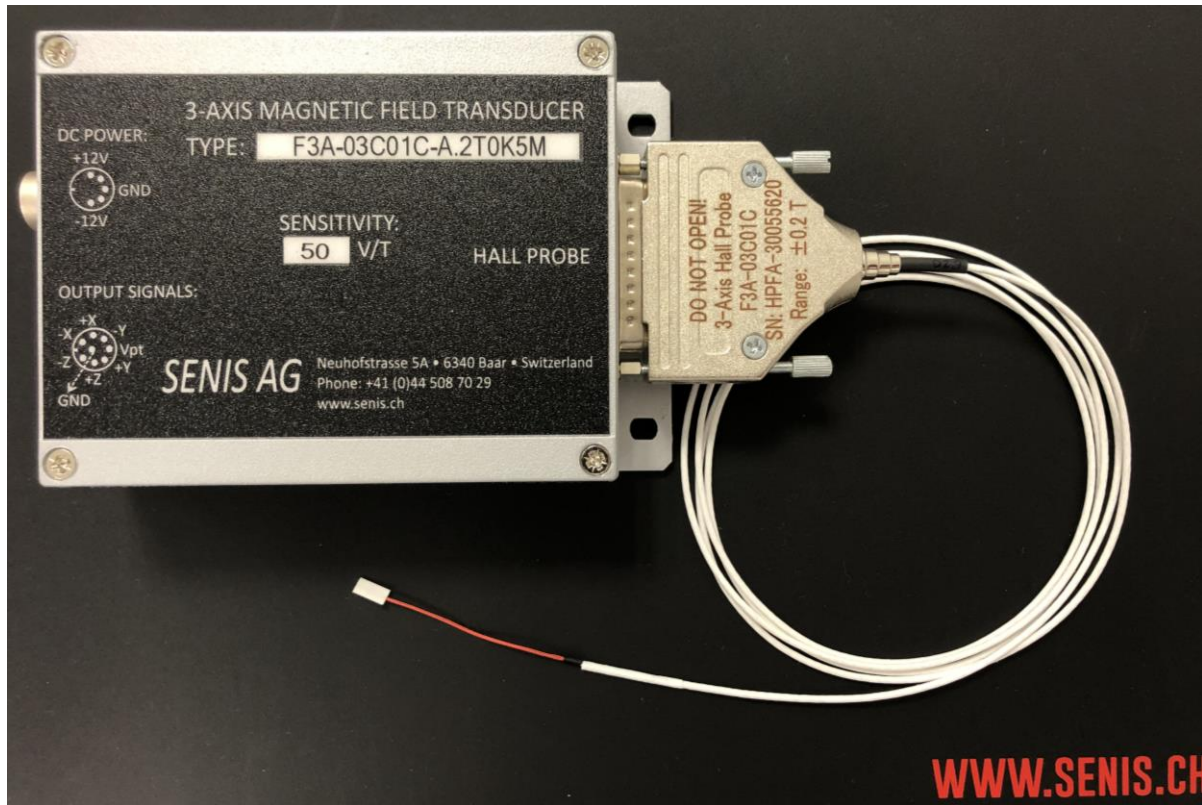





Figure 2. Photo of a 3-axis magnetic field transducer with fully integrated 3-axis Hall Probe

SPECIFICATIONS (Module H):

A number of different geometries/dimensions of Hall probes available that fulfill a wide range of application requirements:

FIGURE				
Probe type	A ¹⁾	C ²⁾	H ³⁾	K ⁴⁾
Ext. dimensions (mm)	16.5 x 5.0 x 2.3	8.0 x 4.0 x 0.9	47.0 x 2.0 x 0.5	47.0 x 2.0 x 0.5

REMARKS:

- 1) Very robust package
- 2) Our standard, robust, very compact package
- 3) Narrow and thin package with mechanically protected chip. It comes in 3 lengths, very long, long and short
- 4) Narrow and thin package. The silicon die is naked to achieve very small measurement distances. It comes in 3 lengths, very long, long and short. Caution: The naked die is sensitive to touch.

For Probe selection, please see Hall Probes Sections at www.senis.ch

The sensor chip is embedded in the probe package and connected to the CaH cable.

CaH Cable - Dimensions and Tolerances:

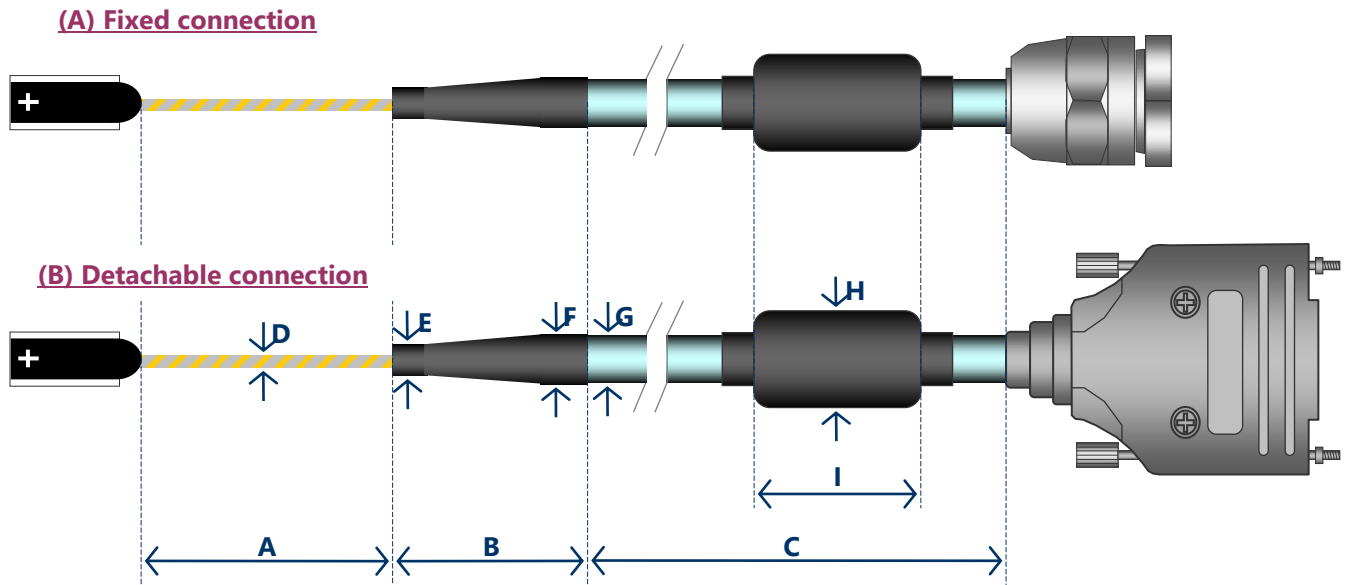

Dimension	mm	Remark
A	50 ± 1	standard for A, C, H and K packages; maximum: up to 1'000 mm
B	35 ± 3	standard for A package
	25 ± 2	standard for C, H and K packages
C	2m, 5m, 10m	Different lengths available upon request
D	∅ 1.7 ± 0.2	standard for A package
	∅ 0.7 ± 0.1	standard for C, H and K packages
E	∅ 3.5 ± 0.3	standard for A package
	∅ 2.1 ± 0.2	standard for C, H and K packages
F	∅ 6.0 ± 0.3	standard for A package
	∅ 2.1 ± 0.2	standard for C, H and K packages
G	∅ 4.9 ± 0.2	standard for A package
	∅ 1.7 ± 0.2	standard for C, H and K packages
H	∅ 13	standard for A package
I	25	standard for A package

Figure 3. Standard dimensions and tolerances of CaH cable (fixed and detachable connection options)

F3x Model Number Chart

F3	x	-	H1	H2	H3	H4	H5	H6	-	E1	E2	E3	E4	E5	E6	E7	E8
Type Id			Module H (6 characters)						Module E (8 characters)								

F3 is Magnetic Transducer Type Identifier

x is a product release version, currently A.

For Module H (6 characters) and Module E (8 characters) see the document MFT Model Numbering Chart.pdf

MAGNETIC and ELECTRICAL SPECIFICATIONS:

NOTE: Unless otherwise noted, please allow for 15 minutes warm up time to achieve optimal performances. The listed specifications apply for all three measurement channels at room temperature (23 °C ± 1 °C).

Parameter	Value				Remarks
Standard measurement ranges	± 20 mT	± 0.2 T	± 3 T	± 20 T	No saturation of the outputs; Other meas. ranges available
Linear range of magnetic flux density (±B _{LR})	± 20 mT	± 0.2 T	± 2 T	± 2 T	Optimal, fully calibrated meas. range
Measurement accuracy (@ B < ±B _{LR})	high	0.1 %	0.1 %	0.1 %	Measured at DC fields as % of full scale; See note 1
	low	1.0 %	1.0 %	1.0 %	
Output voltages (V _{out})	differential				See note 2
Sensitivity to magnetic field (S)	500 V/T	50 V/T	5 V/T	0.5 V/T	Measured at DC fields Differential output; see note 3
Tolerance of sensitivity (S _{err}) (@ B < ±B _{LR})	high	0.03 %	0.03 %	0.03 %	see notes 3 and 4
	low	0.5 %	0.5 %	0.5 %	
Nonlinearity (NL) (@ B < ±B _{LR})	high	0.01 %	0.05 %	0.05 %	See note 4
	low	0.1 %	0.1 %	0.5 %	
Planar Hall voltage (V _{planar}) (@ B < ±B _{LR})	< 0.01 % of V _{normal}				See note 5
Temperature coefficient of sensitivity	< ± 100 ppm/°C (± 0.01 %/°C)				@ Temperature range 20 °C - 35 °C
Long-term instability of sensitivity	< 1 % over 10 years				
Offset (@ B = 0 T)	< ±40 μT	< ±60 μT	< ±0.6 mT	< ±4 mT	@ Temperature range 20 °C - 35 °C
Temperature coefficient of the offset	< ±2 μT/°C	< ±5 μT/°C	< ±50 μT/°C	< ±0.4 mT/°C	
Offset fluctuation and drift (Δt = 0.05 s, t = 100 s)	< 30 μT	< 40 μT	< 100 μT	< 700 μT	Peak-to-peak values; See note 6
Output noise					
Noise Spectral Density @ f = 1 Hz (NSD ₁)	1 μT/√Hz	2 μT/√Hz	7 μT/√Hz	40 μT/√Hz	Region of 1/f – noise
Corner frequency (f _c)	10 Hz				Where 1/f noise = white noise
Noise Spectral Density @ f > 10 Hz (NSD _w)	0.7 μT/√Hz	0.8 μT/√Hz	2 μT/√Hz	16 μT/√Hz	Region of white noise
Broad-band Noise (@ f _c < f < Bw)	depends on the customer's specified frequency bandwidth				RMS noise; see note 7
Resolution					See notes 6 - 10
Typical frequency response					
Frequency Bandwidth (Bw)	0.5 kHz 2.5 kHz 10 kHz max 25 kHz	0.5 kHz 2.5 kHz 10 kHz max 25 kHz	0.5 kHz 2.5 kHz 10 kHz max 25 kHz	max 0.5 kHz	Other frequency bandwidths available; Sensitivity attenuation = -3 dB; See note 11
Output resistance	< 10 Ω, short circuit proof				
Temperature output					
Voltage to ground	V _{PT} [mV] = (T [°C] - 25°C ± 1°C) x 500 [mV/°C] V _{PT} [mV] = (T [°C] - 25°C ± 3°C) x 50 [mV/°C]				See note 12

Magnetic Flux Density (B) units (T-tesla, G-gauss) conversion:

1 T = 10 kG 1 mT = 10 G 1 μT = 10 mG

MODULE E: MECHANICAL AND ELECTRICAL SPECIFICATIONS:

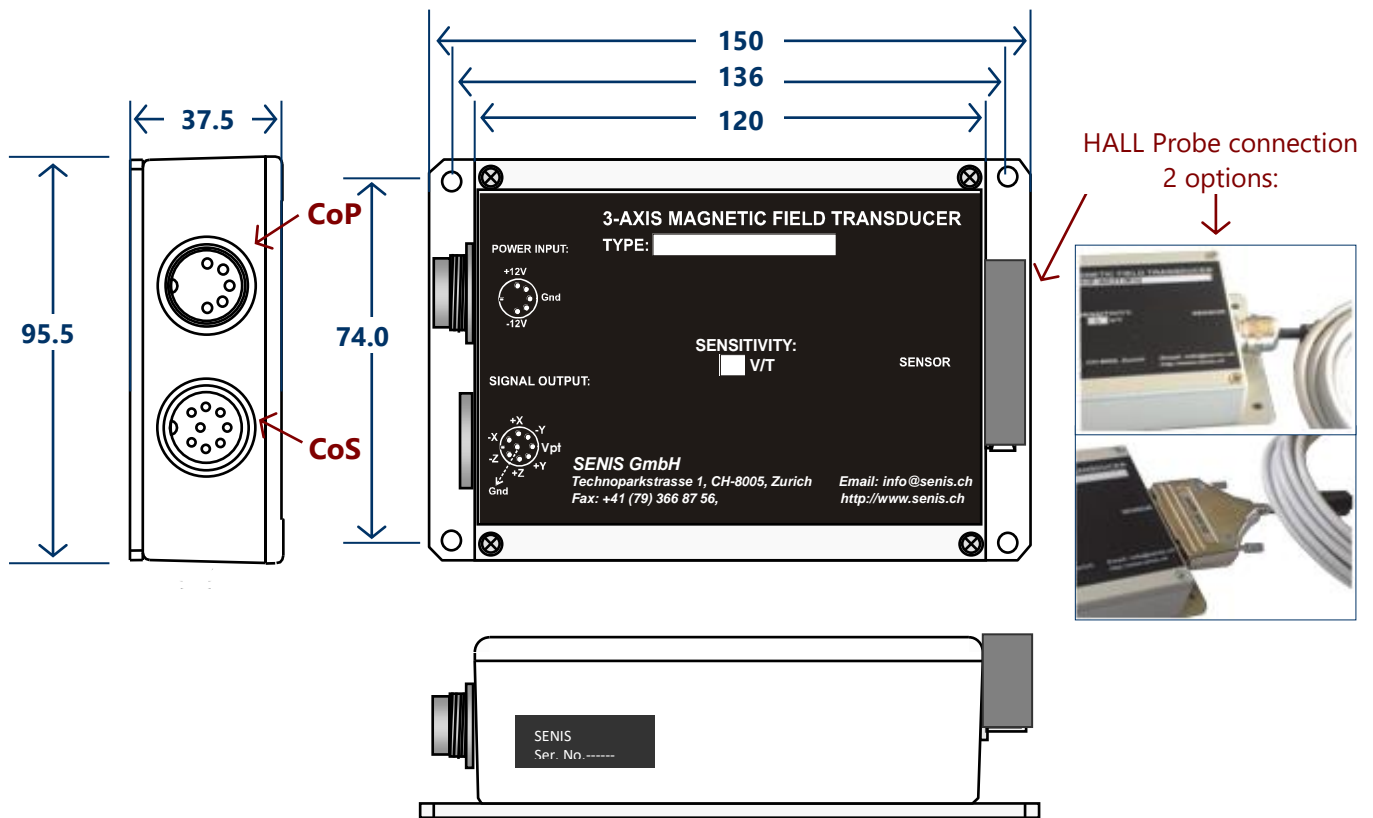

Figure 4. Structure, dimensions and tolerances of the 3-channel analogue electronic module

Module E	High mechanical strength, electrically shielded aluminum case [95 W x 120 L x 37 H mm] with mounting provision (see Fig. 4)	
Connector CoS DIN KFV81, 8 poles (Mating plug SV81)	Field signal X+, X- Field signal Y+, Y- Field signal Z+, Z- Probe Temperature signal Signal common (GND)	Pins 1 and 6, respectively Pins 5 and 4, respectively Pins 3 and 7, respectively Pin 2 Pin 8
Connector CoP DIN SFV50, 5 poles (Mating plug KV50)	Power, +12 V Power, -12 V Power common (GND)	Pin 3 Pin 1 Pin 2
Connector CaH (available options)	<ul style="list-style-type: none"> Fixed connection: Cable gland, MS PG11 Detachable connection: Standard: D-SUB25, SOCKET, 25WAY 	
DC Power	Voltage: Max. Ripple: Current:	±12 V nominal, ±2 % 100 mVpp max. 80 mA
Environmental Parameters:		
Operating Temperature	+5 °C to +45 °C	Option: up to +160 °C for the H-Module
Storage Temperature	-20 °C to +85 °C	

The ADDITIONAL CALIBRATION OPTIONS

1. DC Calibration Table (Voltage vs. Bref)

The DC calibration table of the transducer can be ordered as an option. The DC calibration table is an Excel-file, providing the actual values of the transducer output voltage for the test DC magnetic flux densities measured by a reference high-precision NMR Teslameter PT2025, or a high-accuracy 3-axis digital Teslameter 3MH6 (accuracy 100 ppm, verified against the NMR standard).

The standard DC calibration table covers the linear range of magnetic flux density $\pm B_{LR}$ measured in the steps of $B_{LR}/10$. Different DC calibration tables are available upon request. By the utilisation of the DC calibration table, the accuracy of DC and low-frequency magnetic measurement can be increased up to the limit given by the DC resolution of the device (see Notes 1 and 6 - 10).

2. AC Calibration Table - Frequency Response characterization

Another option is the AC calibration table (Amplitude and Phase vs. Frequency) of the frequency response. This is an Excel file, providing the actual values of the transducer transfer function (complex sensitivity and Bode plots) for a reference AC magnetic flux density. The standard frequency response calibration table covers the transducer bandwidth from DC to Bw , measured in the steps of $Bw/10$. Different AC calibration tables are also available upon request. By the utilisation of the frequency response calibration table the accuracy of the AC magnetic fields measurements can be improved almost up to the limit given by the AC resolution of the transducer (see Notes 1 and 6 - 11).

SENIS 3-axis Hall probe is applicable in the B-frequency range from DC to Bw (-3 dB point of sensitivity attenuation, where B being the density of the measured magnetic flux). In addition to the Hall voltage, at high B-frequencies also inductive signals are generated at the connection probe-thin cable. Moreover, the probe, the cable and the electronics in the E-module behave as a low-pass filter. As a result, the transducer has the "complex" sensitivity of the form:

$$S = S_H + jS_I$$

Here:

- S_H represents sensitivity for the output signal in phase with the magnetic flux density (that is the real part of the transfer function);
- S_I is the sensitivity with the 90° phase shift with respect to the magnetic flux density (i.e., the imaginary part of the transfer function).

Calibration data can be ordered for S_H and S_I for all three axes X, Y and Z (as an option). This allows the customer to deduce accurate values of the measured magnetic flux density at even high frequencies by an appropriate mathematical treatment of the transducer output voltage V_{out} .

NOTES:

- 1) The **accuracy** of the transducer is defined as the maximum difference between the actual measured magnetic flux density and that given by the transducer. In other words, the term accuracy expresses the maximum measurement error. After zeroing the offset at the nominal temperature, the worst-case relative measurement error of the transducer is given by the following expression:

$$\text{Max. Relative Error: M.R.E.} = S_{\text{err}} + NL + 100 \times \text{Res} / B_{\text{LR}} \quad [\text{unit: \% of } B_{\text{FS}}] \quad \text{Eq. [1]}$$

Here, S_{err} is the tolerance of the sensitivity (relative error in percents of S), NL is the maximal relative nonlinearity error (see note 4), Res is the absolute resolution (Notes 6 - 10) and B_{LR} is the linear range of magnetic flux density.

- 2) The output of the measurement channel has two terminals and the output signal is the (differential) voltage between these two terminals. However, each output terminal can be used also as a single-ended output relative to common signal. In this case the sensitivity is approx. 1/2 of that of the differential output.

Note: The single-ended outputs of the transducer are not calibrated.

- 3) The **sensitivity** is given as the nominal slope of an ideal linear function $V_{\text{out}} = f(B)$, i.e.

$$V_{\text{out}} = S \times B \quad \text{Eq. [2]}$$

where V_{out} , S and B represent transducer output voltage, sensitivity and the measured magnetic flux density, respectively.

- 4) The **nonlinearity** is the deviation of the function $B_{\text{measured}} = f(B_{\text{actual}})$ from the best linear fit of this function. Usually, the maximum of this deviation is expressed in terms of percentage of the full-scale input. Accordingly, the nonlinearity error is calculated as follows:

$$NL = 100 \times \left[\frac{V_{\text{out}} - V_{\text{off}}}{S'} - B \right]_{\text{max}} / B_{\text{LR}} \quad (\text{for } -B_{\text{LR}} < B < B_{\text{LR}}) \quad \text{Eq. [3]}$$

Notation:

B = Actual testing DC magnetic flux density given by a reference NMR Teslameter

$V_{\text{out}}(B) - V_{\text{off}}$ = Corresponding measured transducer output voltage after zeroing the Offset

S' = Slope of the best linear fit of the function $f(B) = V_{\text{out}}(B) - V_{\text{off}}$ (i.e. the actual sensitivity)

B_{LR} = Linear range of magnetic flux density

Tolerance of sensitivity can be calculated as follows:

$$S_{\text{err}} = 100 \times |S' - S| / S \quad \text{Eq. [4]}$$

- 5) The **planar Hall voltage** is the voltage at the output of a Hall transducer produced by a magnetic flux density vector co-planar with the Hall plate. The planar Hall voltage is approximately proportional to the square of the measured magnetic flux density. Therefore, for example:

$$\left. \frac{V_{\text{planar}}}{V_{\text{normal}}} \right|_{@B=B_0} = 4 \times \left. \frac{V_{\text{planar}}}{V_{\text{normal}}} \right|_{@B=B_0/2} \quad \text{Eq. [5]}$$

Here, V_{normal} denotes the normal Hall voltage, i.e., the transducer output voltage when the magnetic field is perpendicular to the Hall plate.

- 6) This is the “6-sigma” peak-to-peak span of offset fluctuations with sampling time $\Delta t = 0.05$ s and total measurement time $t = 100$ s. The measurement conditions correspond to the frequency bandwidth from 0.01 Hz to 10 Hz. The “6-sigma” means that in average 0.27 % of the measurement time offset will exceed the given peak-to-peak span. The corresponding root mean square (RMS) noise equals 1/6 of “Offset fluctuation & drift”.
- 7) Total output RMS noise voltage (of all frequencies) of the transducer. The corresponding peak-to-peak noise is about 6 times the RMS noise. See also Notes 8 and 9.
- 8) Maximal signal bandwidth of the transducer, determined by a built-in low-pass filter with a cut-off frequency Bw . In order to reduce the output noise or avoid aliasing, the frequency bandwidth may be limited by passing the transducer output signal through an external filter (see Notes 9 and 10).
- 9) **Resolution** of the transducer is the smallest detectable change of the magnetic flux density that can be revealed by the output signal. The resolution is limited by the noise of the transducer and depends on the frequency band of interest.

The **DC resolution** is given by the specification “Offset fluctuation & drift” (see also Note 6).

The worst-case (**AC resolution**) is given by the specification “Broad-band noise” (see also Note 7).

The resolution of a measurement can be increased by limiting the frequency bandwidth of the transducer. This can be done by passing the transducer output signal through a hardware filter or by averaging the measured values.

Caution: filtering produces a phase shift, and averaging causes a time delay!

The RMS noise voltage (i.e., resolution) of the transducer in a frequency band from f_L to f_H can be estimated as follows:

$$V_{nRMS-B} \approx \sqrt{NSD_{1f}^2 \times 1\text{Hz} \times \ln\left(\frac{f_H}{f_L}\right) + 1.16 \times NSD_W^2 \times f_H} \quad \text{Eq. [6]}$$

Notation:

- NSD_{1f} is the 1/f noise voltage spectral density (RMS) at $f = 1$ Hz;
- NSD_W is the RMS white noise voltage spectral density;
- f_L is the low, and f_H is the high-frequency limit of the bandwidth of interest; and
- the numerical factor 1.57 comes under the assumption of using a first-order low-pass filter.

For a DC measurement:

$$f_L = 1/\text{measurement time.}$$

The high-frequency limit cannot be higher than the cut-off frequency of the built-in filter Bw :

$$f_H \leq Bw.$$

If the low-frequency limit f_L is higher than the corner frequency f_C , then the first term in Eq. (6) can be neglected. Otherwise, if the high-frequency limit f_H is lower than the corner frequency f_C , then the second term in Eq. (6) can be neglected. The corresponding peak-to-peak noise voltage can be calculated according to the “6-sigma” rule:

$$V_{nP-P} \approx 6 \times V_{nRMS-B}.$$

- 10) According to the sampling theorem, the sampling frequency must be at least two times higher than the highest frequency of the measured magnetic signal. Let us denote this signal sampling frequency by f_{samS} . However, in order to obtain the best signal-to-noise ratio, it is useful to allow for over-sampling (this way we avoid aliasing of high-frequency noise). Accordingly, for best resolution, the recommended physical sampling frequency of the transducer output voltage is

$$f_{samP} > 5 \times Bw \quad (\text{or } f_{samP} > 5 \times f_H, \text{ if an additional low-pass filter is used, see Note 8}).$$

The number of samples can be reduced by averaging every N subsequent samples, where $N \leq f_{samP} / f_{samS}$.

- 11) When measuring fast-changing magnetic fields, one should take into account the transport delay of the Hall signals, small inductive signals generated at the connections Hall probe–thin cable, and the filter effect of the

electronics in the E-Module. Approximately, the transducer transfer function is similar to that of a third-order Butterworth low-pass filter, with the cut-off frequency Bw .

The attenuation of the applied filters is -60 dB/dec (-18 dB/oct).

The AC calibration table of the frequency response is available as an option.

12) The equation:

$$V_{PT}[\text{mV}] = (T[^\circ\text{C}] - 25^\circ\text{C} \pm 1^\circ\text{C}) \times 500 [\text{mV}/^\circ\text{C}]$$

is valid for the standard temperature range between +5 °C - +45 °C.

For less accurate high temperature calibrations in the range between +20 °C - +160 °C use the equation

$$V_{PT}[\text{mV}] = (T[^\circ\text{C}] - 25^\circ\text{C} \pm 3^\circ\text{C}) \times 50 [\text{mV}/^\circ\text{C}]$$

instead to calculate the temperature of the sensor from the temperature voltage output.

The Temperature voltage output of the transducer is taken from a calibrated temperature sensor on the Hall probe itself. It therefore measures the local temperature of the Hall elements. Due to power loss in the sensor the sensor temperature is always higher than the environmental temperature. The difference between the temperature of the sensor and the environment is more pronounced if the sensor tip is free hanging in the air. In this case the sensor is between 5 °C and 15 °C hotter than the environment. If the sensor is well attached or clamped down on a heat conducting surface, such as a metal, the sensor is typically between 1 °C and 4 °C hotter than the environment.